

ML211A Solar Marine Lantern

	<p>Products description and application ML211A marine lantern can meet the visible distance of 2 nautical miles Applicable to the marine buoys, river buoys, shore, fixed light beacon and offshore oil derrick lights and so on. Ideal for harsh environments.</p> <p>Features Based on LED technology, its color complies to IALA Recommendations E-200-1. Integrated design, enabling a rugged and completely waterproof seal capable of prolonged and deep immersion (IP68). PC material, UV resistance, shockproof , corrosion-resistant, with bird spike. 256 kinds of flashing rate are available, comply with IALA. Adjustable light intensity, photocell controls on/off automatically, the value of illuminance switch can be adjusted Extremely reliable and low maintenance costs. GPS (optional). GSM remote control (optional). Flame retardant level: UL94-V0.</p>
---	--

General Specifications

Implementation Standard	JT/T 761-2009 JT 7007-1993 GD22-2015 IALA Recommendation E-200-1	Marine lantern general technical conditions Marine lantern intensity measurement and light range calculation Electrical and electronic products type approval test guide Marine Signal Lights Part 1 – Color Edition 1
-------------------------	---	---

Electrical parameters		Mechanical structure parameters	
Rated Voltage	Monocrystalline silicon solar panel	Main material	Body ABS+PC PC housing PC
Maximum power	5V/1.8W	Ambient Humidity	0% ~ 90% RH(No condensation)
Battery	NiMH	Weight	2.1 Kg
Battery capacity	3.6V/10Ah	Operating temperature	Ta-40°C ~ +60°C
Lelectromagnetic compatigility	GD22-2015	IP rate	IP 66
Electrostatic discharge	Air discharge 15KV Contact discharge 8KV	Color	White

Optical parameters	
Light emitting element	LED
Working way	256 kinds of floashing rate adjunstable
Vertical degree	≥7°
Horizontal degree	360°
Color	Red, green, blue, yellow, white
Photocell ilumination threshold	200-500LX (adjustable)
Visible Range	2nm (10cd, intensity gear 100%)
Autonomy	20 days (12,5% duty cycle, 14 hours darkness)

Mounting dimensions

Unit mm

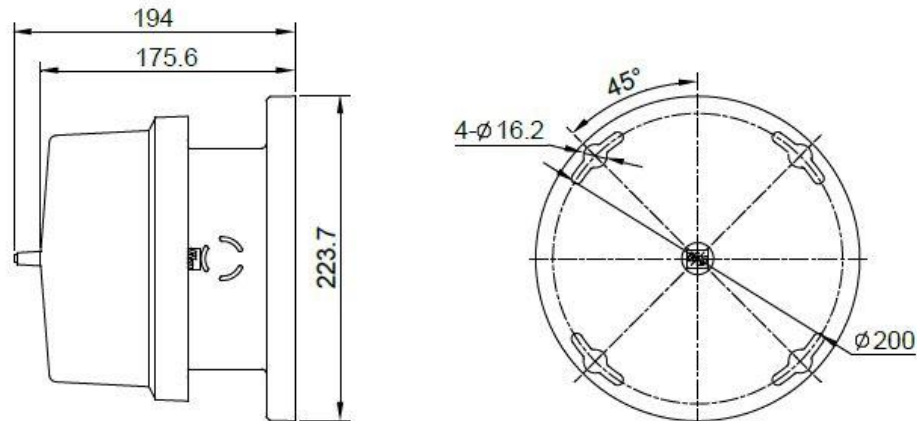

Installation instruction

1 Open the box, the package contains the following items:

NO	Material name	Quantity(pcs)	Description
1	Marine lantern	1	Marine lantern
2	Infrared remote control	1	Align the digital tube remote control operation ²
3	Ziplock bag	1	Equipped with other spare parts.
4	English manual and warranty card	1	manual, warranty card. ³

1. Please refer to the infrared remote control instructions for use, and safekeeping.
2. Please keep for long time.

2.Mounting and battery maintenance

- Before installing and fixing, please check if the battery is contacted well and fully charged.(The battery voltage can be read in the digital tube, the value should not be lower than 3.8V),Products with GSM function also confirm that SIM card is installed
- If the battery is low, try placing it in the sun and charging it with the solar panel which comes with the light. In order to charge faster, it is recommended to set the light to the off state.Please make sure the battery is contacted well when illuminate the solar panels with sunlight or other strong light sources.
- The light should be installed in a sunny location.
- The light with built-in Ni-MH battery. After use for 15 months (450 times),the battery capacity is about 80% of the initial value, please replace the battery in time.
- When replacing the battery, please set the light to off state, then open the bottom cover, replace the new battery, fix the bottom cover, and then set the light back to auto state. Please select the battery with the same specifications and pay attention to the positive and negative poles. Sunlight and other strong light sources are not allowed to be applied to the solar panels during battery replacement.

3.SIM card installation instructions (only fit for products with GSM,please select SIMCARD)

- Use a Phillips screwdriver to open the bottom cover of the light.
- SIM card into the SIM card slot, hear a click, indicating that the installation is complete; pay attention SIM card insertion direction;
- After confirmation, fasten the bottom cover with a Phillips screwdriver, and pay attention to the installation direction of the bottom cover (positioning bayonet at one end, as shown below).









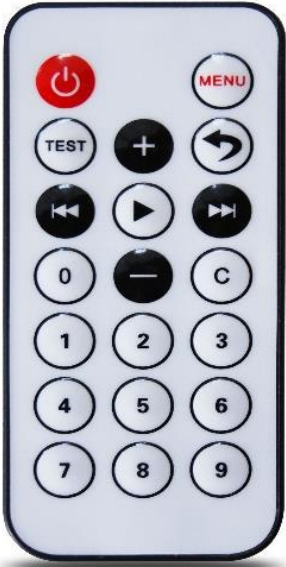

4. Digital tube display instructions

- 1) Turn on the power, the light into the self-test state, the digital display shows the current self-test items.
- 2) When the digital display "atgd", self-test normal, then enter the sleep state.
- 3) When the LED display "ater", self-test anomalies, and then into hibernation.
- 4) If there is a self-test abnormality, please check whether the SIM card and SIM card are in normal use status.
- 5) Press any button on the remote to wake up the digital tube to enter the display state.
- 6) Display status, the digital tube alternately displays the current page and the corresponding page value.
- 7) Setting state, digital tube still display the current page value.
- 8) 1 minute without key operation remote control, digital tube in hibernation (not shown).
- 9) Digital control of the page, the page value and meaning of the table below:

Page	Page Value	Meaning
Stat	On	Manually turn on the lights, light control does not work in this state, the lights always work.(Do not keep this mode for a long time.)
	Off	Turn off the light manually,light control does not work in this state, the light is always off
	auto	Automatic, light control works. (Factory setting is auto)
Flsh	0-255	IALA flash rate (ie, flashing mode), and light quality table corresponding.1 (factory setting is 248)
eInt	0p-100p	Light gear. (Set according to the visual range, the default 100p)
D2n	0-650l	Evening, the light control automatically turn on the light illumination value, in Lx. (Factory setting is 300l)
N2d	0-650l	At dawn, light control automatically turn off the light illumination value, in Lx. 2 (Factory setting is 400l)
Batt (Non-setting items)	4.0 (for example)	The current DC power supply voltage 4.0 V
GPS (Non-setting items)	Srch	GPS is in the search star status
	good	GPS is in normal
Lerr (Non-setting items)	Ok	Normal
	err	alarm

- 1.The flashing mode can be downloaded from the official website or contact sales staff.
2. N2d setting value must be bigger than d2n



5. Infrared remote control operating instructions



Picture for reference, please prevail in kind	Instructions
	<p>When first used, remove the insulation sheet from the bottom of the remote control. Aim the remote control at the digital tube, press any key to wake up digital tube, enter the display state.</p> <p>Press  /  page, Left / right to switch the page, digital tube alternately displays the current page, page value.</p> <p>Switch to the desired settings page,  Enter the setting state, digital tube static display the current page value.</p> <p>Press/  / , Increase / decrease to set the current page value, you can also press the number keys to directly modify the current page value.</p> <p>To save the settings,  press Key to save and exit the setting status. If you do not need to save, press  Exit the setting status directly.</p> <p>No key within 1 minute, digital tube automatically go to sleep. If you do not use the remote control for a long time, please insert the insulation sheet back into place.</p>

6. Infrared remote control operating examples

stat light mode setting example: Set auto mode

1.If LED display is in sleeping status, press any key to awake LED display and enter into display status.



2.Press  /  page down/up to stat page. And then press  enter into setting status. LED display indicate current light mode statically.



3.Press  /  to switch over among on/off/auto. Find demanded page: auto.

4.Press  save and quit setting status.

flsh light character setting example Set flashing 123

1.If LED display is in sleeping status, press any key to awake LED display and enter into display status



2.Press  /  page down/up to FLSH page. And then press  enter into setting status. LED display indicate current light character statically.



3.Press  /  plus/minus. Adjust to value 123. Or press digital key 1,2,3 in turn. LED display indicates 123.

4.Press  save and quit setting status.

Elnt Intensity setting instruction example Set intensity 30p

1.If LED display is in sleeping status, press any key to awake LED display and enter into display status



2.Press  /  / page down/up to elnt page. And then press  enter into setting status. Led display indicate current light intensity statically.



3.Press  /  plus/minus. Adjust to value 30p. Or press digital key 3, 0 in turn. LED display indicate 30p.

4.Press  save and quit setting status.

d2n Indicates the ambient brightness (in lx) at which the lantern LEDs will turn on in the evening. setting example Set 300L











1.If LED display is in sleeping status, press any key to awake LED display and enter into display status

2.Press  /  page down/up to d2n page. And then press  enter into setting status. LED display will indicate illuminance value.

3.Press  /  plus/minus. Adjust to value 300L. Or press digital key 3,0,0 in turn. LED display indicate 300L.

4.Press  save and quit setting status.





n2d Indicates the ambient brightness(in lx)at which the lantern LEDS will turn off in the morning. setting example



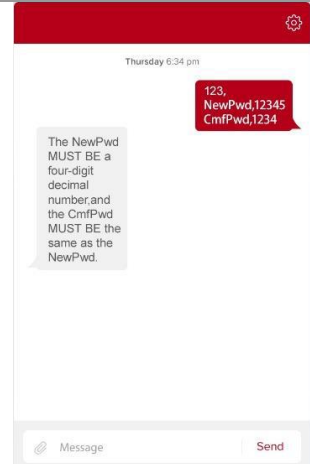

<p>Set 400L</p> <p>1.If LED display is in sleeping status, press any key to awake LED display and enter into display status</p> <p>2.Press   page down/up to n2d page. And then press  enter into setting status. LED display will indicate illuminance value.</p> <p>3.Press plus/minus. A djust to value 400L. Or pres digital key 4,0,0 in turn. LED display indicate 400L.</p> <p>4.Press  save and quit setting status.</p>
<p>Batt battery voltage checking</p> <p>1.If LED display is in sleeping status, press any key to awake LED display and enter into display stat us</p> <p>2.Press   page down/up to batt page. LED display will indicate batt and current voltage value alternately.</p>
<p>Gps GPS signal status</p> <p>1.If LED display is in sleeping status, press any key to awake LED display and enter into display status</p> <p>2.Press   page down/up to gps page. LED display will indicate gps and GPS signal status: Srch(searching) or good(si gnal is good).</p>
<p>Lerr alarm status</p> <p>1.If LED display is in sleeping status, press any key to awake LED display and enter into display status</p> <p>2.Press   page down/up to lerr page. LED display will indicate alarm status: ok(normal) or err(fault).</p>

7 .Other functions

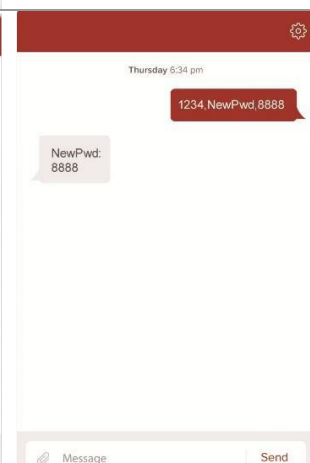
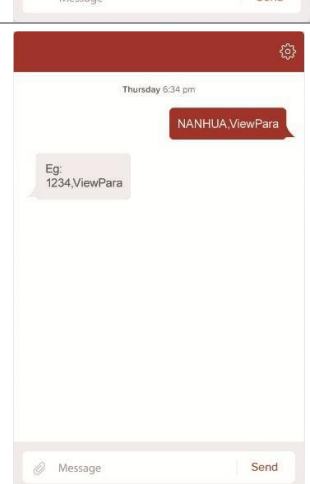
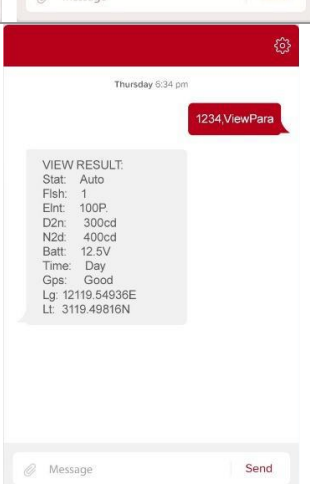
- Fault alarm** Through the digital control, GSM prompt fault. (Need to select the corresponding function)
- Photocell** According to the value of environmental illumination, the lights turn on and off automatically. (Need stat page value is auto)
- GSM (optional)** Send a "NANHUA" message to the SIM card number to receive a message. (See GSM operation instructions)
- GPS (optional)** With the same flash rate, the light will flashing simultaneously.

GSM operation instruction	
<p>Picture for reference, please prevail in kind</p> <p>No picture</p> 	<p>Instructions</p> <p>Preparation before operation Turn on the switch self test normal. Phone input method set to English.</p> <p>Receive operating instructions Send SMS "NANHUA" and get a reply message with instructions.</p>

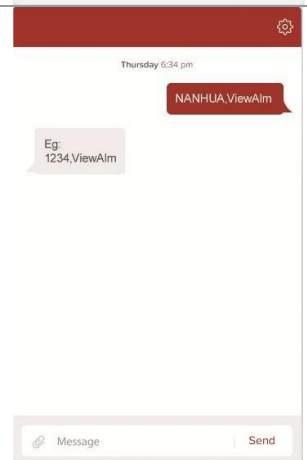
		<p>Set a new password</p> <ol style="list-style-type: none"> 1. Send SMS "NANHUA, NewPwd" to the light to get message prompt, as shown in the left picture 1. 2. You can also send text messages "old password, NewPwd, new password, CfmPwd, confirm the new password", as shown in the left picture 2.
		<p>Set new password failed prompt</p> <p>If the new password format does not meet the requirements or enter a new password twice inconsistent will receive a prompt message, as shown in the left.</p>
		<p>Set the alarm to receive the phone number</p> <ol style="list-style-type: none"> 1. Send SMS "NANHUA, AlmPhn" to the luminaire, get message prompt, as shown in the left picture 1. 2. Can also directly send text messages "password, AlmPhn, cell phone number", as shown in the left picture 2.
		<p>Read the parameters</p> <ol style="list-style-type: none"> 1. Send SMS "NANHUA, ViewPara" to the light, get message prompt, as shown in the left picture 1. 2. Can also send text messages directly "password, ViewPara", as shown in the left picture 2.

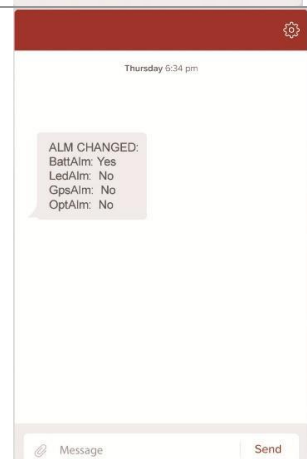
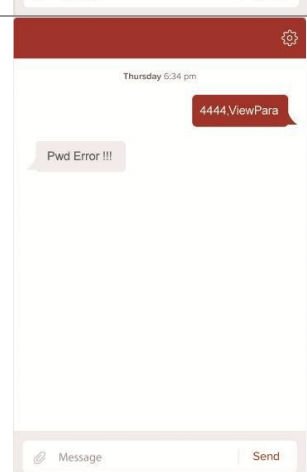
		<p>Setting parameters</p> <ol style="list-style-type: none"> 1. Send a message "NANHUA, SetPara" to the light, get message prompt, as shown in the left picture 1. 2. Can also send text messages directly "password, SetPara: Stat:On Flsh:2 Elnt:50 D2n:400 N2d:500", as shown in the left picture 2. <p>Noted: Only need to input the parameters must be changed. For example, the light intensity can be modified as follows: „Password, settPara: Eint:50”</p>
		<p>Read the fault alarm status</p> <ol style="list-style-type: none"> 1. Send SMS "NANHUA, ViewAlm" to the light, get message prompt, as shown in the left picture 1. 2. Can also send text messages directly "password, ViewAlm", as shown in the left picture 2.
	<p>Alarm status change, receive active reminder SMS</p> <p>Need to set the alarm to receive mobile phone number in advance.</p>	
	<p>Password error message</p> <p>Please enter the correct password to continue.</p>	

Precautions

Products using PC material components (such as PC housing), can not be with industrial alcohol, banana water, isopropyl alcohol, carbon tetrachloride, cyclohexanone and other organic solvents directly or indirectly contact, otherwise it will be corrosion cracking.

This product light control detected ambient illumination changes, the switch state will have a few seconds delay.

There will be a few seconds of light fault alarm alarm, is a normal phenomenon.

Light control fault alarm has a 24-hour delay, is a normal phenomenon.

GPS fault alarm 1 hour delay, is a normal phenomenon.

Before disconnecting the power supply, do not open any part of the light body to prevent any danger.

Do not look directly at the light out of the light, so as not to damage the eyes.

Thanks for choosing our products, is the professional brand of signal transmission and high quality industrial lighting which is trusted and loved by global users from various industries.

Read and understand these instructions completely and carefully. Wrong installation and operation may lead to fires, electric shock, and others. Due to our continued efforts to improve our products, product specifications are subject to change without notice.